



Perception wireless

!



1	3
	3
	3
2	4
	4
	4
	4
SR 45	5
	5
	6
HT 45	7
	7
PT 45	8
	8
	9
3	10
	10
	10
	10
	10
	10
	10
	11
	11
	11
	11
	12
	12
4	13
HT 45	13
	13
	13
	13
	13
PT 45	14
CK 55 L	14
CK 544 L	14
	14
	14
	14
5	15
	15
	15
6	16
7	17

-
-
-

-
-

12

-

-

-

-

-

-

AKG



-

-

-

AKG.

Perception wireless

4

SR 45:

(Vocal Set)	
HT 1	.
1	.
AA 1	.
SR 45 1	.
	SMPS 1
1	.
1	.
	1

(Presenter Set)	
PT 45 1	.
AA 1	.
	CK 55 L 1
W 444 1	.
SR 45 1	.
	SMPS 1
1	.
1	.
	1

(Instrumental Set)	
PT 45 1	.
AA 1	.
MKG L 1	.
SR 45 1	.
	SMPS 1
1	.
1	.
	1

(Sports Set)	
PT 45 1	.
AA 1	.
	CK 544 L 1
	4
W 444 1	.
SR 45 1	.
	SMPS 1
1	.
1	.
	1

AKG.

AKG

www.akg.com.

SR 45

SR 45 -
Perception.

SR45

500 865

30

8



Рисунок 1: Элементы управления на передней панели приемника SR45

- 1 ON/OFF: / .
- 2 VOLUME:
- 3 RF OK: , (squelch),
- 4 :
- 5 CLIP: ,
- 6 CHANNEL: 8 ,



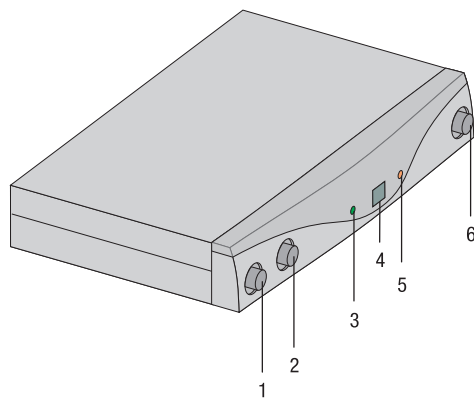

Рисунок 2: Элементы управления на задней панели приемника SR45

- 1 :
8
- 2 SQUELCH: Squelch ,
,
- 3 AUDIO OUT/BALANCED: 3- XLR.
,
- 4 AUDIO OUT/BALANCED: 1/4" (6,3) -
,
- 5
- 6 DC IN:

HT 45

30

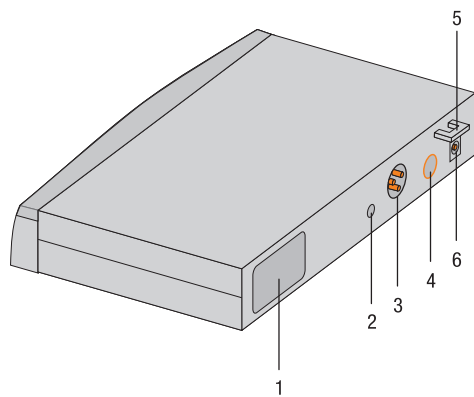
HT45

8

500 865

1 :

2 CHANNEL:

8

3 GAIN:

: "HI" =

, "LOW" =

4 :



Рисунок 3: Элементы управления передатчика HT 45

5 ON/OFF:

ON:

MUTE:

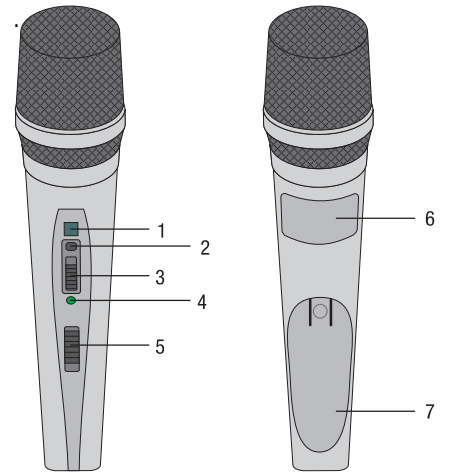
OFF:



15

6 :

8

7 :

ручных/поясных передатчиках

Вставка и проверка батареек в

PT 45

PT 45

4

PT 45

500 865

30

8

1 ON/OFF:

ON:

MUTE:

OFF:

2 : 3-

XLR

AKG,
MKGL.

3 :

4 :

5 :



Рисунок 4: Элементы управления передатчика PT 45



15

6

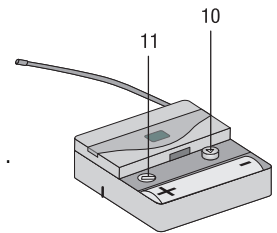
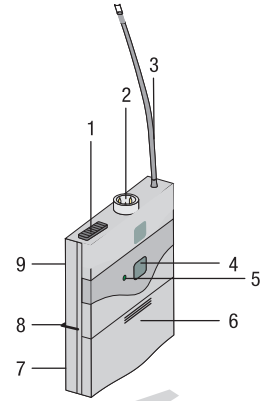
7

8

9

8

10 CHANNEL:

8

11 GAIN:



PT 45

AKG:

- CK 55 L, C 417 L, C 520 L, C 555 L, C 544 L, C 577
- C 516 ML, C 518 ML, C 519 ML, C 411
- MKG L AKG

MKG L



 Perception wireless ().

-
-

1) (3).

5

2)

3)

1,5

1)

XLR

(XLR)

2)

VOLUME

1)

1/4" (6,3)

1/4" (6,3)

2)

VOLUME

 3

1)

2)

DC IN

3)

4)

ON/OFF

1)

2)

3)

4)

'ON'.



15

5)

1)

(, 1)
3

CHANNEL.

2)

CHANNEL.

3)

3

1)

SQUELCH

2)

'ON'.

3)

4)

•

CLIP

GAIN

"HIGH".

•

CLIP

GAIN

"LOW".

5)

PT 45

AKG

CK 55 L,

C 411, C 417 L, C 520 L, C 555 L, C 516 ML, C 518 ML C 519 ML.

AKG

PT 45,

3-

-XLR.

1:

2:

(+)

3:

3

4



AKG

PT 45

1)

2)

-XLR

3)

'ON'.

4)

SQUELCH

5)

6)

7)

GAIN

CLIP

8)



- 1)
- 2) MKG L -XLR 'ON'.
- 3) SQUELCH
- 4)
- 5)
- 6) GAIN CLIP
- 7)
- 1)
- 2) RF OK squelch. squelch RF OK.
- 3)

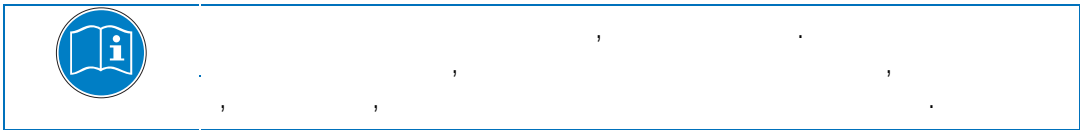

1)

 ,

2)

CK 544 L

1)

2)

 • " " " " () .

• " " ,

•

(,)

1)

2)

544



-
- 1)
- 2) ()
- 3)
- 4)

6

		ON/OFF
	VOLUME	
	"OFF" "MUTE".	"ON".
		Perception
	GAIN	
		Perception

	HT 45	PT 45	SR 45
	500 - 865	500 - 865	500 - 865
	FM	FM	FM
	70 - 20000	40 - 20000	40 - 20000
	0,8%	0,8%	0,8%
	105 ()	105 ()	105 ()
	10	10	
	1 1,5	1 1,5	-
	10	10	-
Squelch	-	-	-100 -70
	-	-	XLR 1/4" (6,3): : 500 rms
	229 x 53 x 53	60 x 74 x 30	200 x 190 x 44
	214 .	60 .	360 .

sales@akg.com. <http://www.akg.com>



• • • • •

AKG Acoustics GmbH

Lemböckgasse 21-25, A-1230 Vienna/AUSTRIA, phone: (+43-1) 86654-0*
e-mail: sales@akg.com

, www.akg.com

     ROHS OK

 A Harman International Company

05/10

